

PressLine INC

AB Dick & Itek Parts and Accessories Catalog.

**AB Dick Parts
Order Online
Or Phone
Check our web-
site AB Dick
parts list for sale
prices & parts in
stock New &
Used**

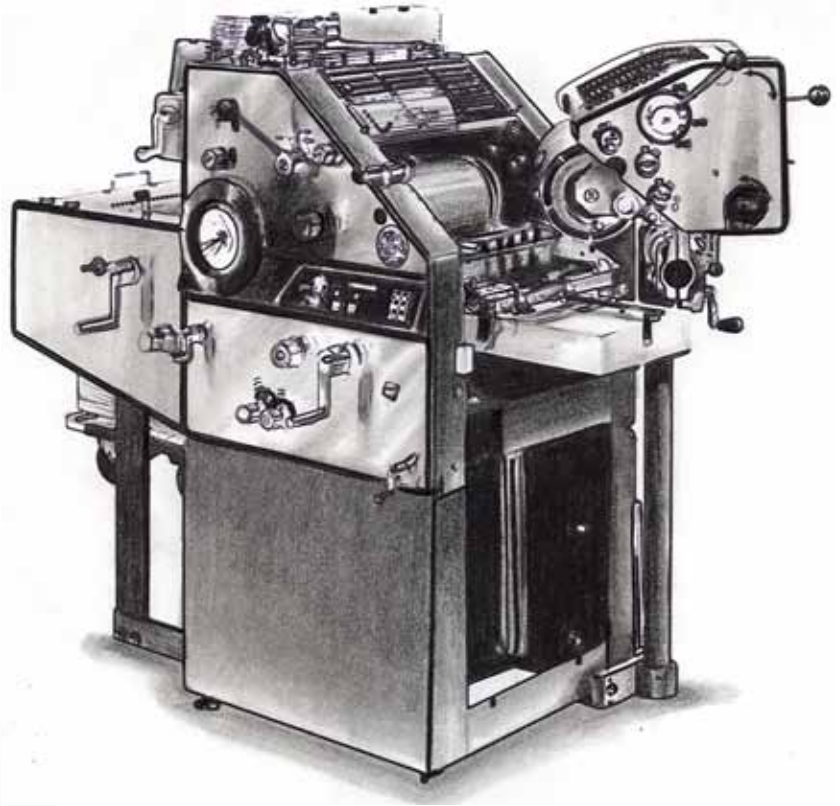

Pressline Printing Equipment Inc.
This website has only sample of our total
inventory of over 5000 different items &
parts in stock if you don't see it just
E-mail presslineonline@gmail.com
Just Call 360-674-2009

Website www.presslineonline.com

E-mail presslineonline@gmail.com

PAYMENT (Master Card - Visa) Phone (360-674-2009)

Preferred Payment PAY - PAL

Washington
360-674-2009

All Information Is Believe To Be Correct But No Guarantee Is Given.

Ordering Instructions Inside.

Copyright 1990 Printed In U.S.A.

Cradle Repair Kit For 8800 & 9800 series.

Complete Kit	A-98037	\$114.00
(A) Washer	P-613	\$ 1.75
(B) Hex nut	P-514	\$ 0.75
(C) Retaining ring	P-707	\$ 1.00
(D) Shaft	A-98038	\$ 56.60
(E) Key	A-1745	\$ 1.75
(F) Ball bearing-2	A-11149	\$ 16.05
(G) Steel bushing	A-98058	\$ 17.10

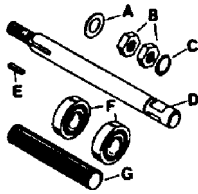

Adjusting Clamp	A-36087	\$ 29.90
Thumb Screw	A-1539	\$

Sucker & Sucker Foot	A-80220	\$9.90
----------------------	---------	--------



AB Dick Air Valve Assembly

Complete	A-36847	\$164.00
(A) Valve body	A-36844	\$ 66.25
(B) Shaft	A-36841	\$ 21.30
(C) Plug	A-36951	\$ 9.50
(D) Spring inside	A-36859	\$ 3.10
(E) Valve inside	A-36845	\$ 23.45
(F) Roll pin	P-379	\$ 0.69

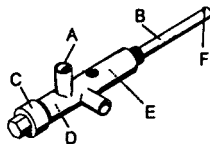

Chain Delivery Safety Guides Arms for 9800 1 to 1 Chain		
Operators side - complete	A-984289	\$36.30
Arm only OS	A-984290	\$30.90

Non - side - complete	A-984279	\$30.90
Arm only NOS	A-984280	\$30.95
Cam	P-1475	\$580
Pin	P-3012	\$3.90
C-ring	P-679	\$0.75

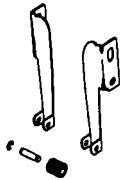

Lift Gate Cam & Collar Assembly

350, 366, 375,	A-81850	\$53.40
375, 9800	A-81850	\$53.40



CHAIN BACK STOP SPRING

Made with spring steel.		
Complete with cam		
350, 360, 375, 385.	A-81846	\$64.00
9800- Complete with cam	A-17577	\$80.15



Chain Back Stop

350, 360, 375.	A-73993	\$246.00
9800	A-17573	\$149.80
9800 1-1	A-982420	\$128.30



NEW INK FOUNTAIN CRANK REPLACEMENT

For AB Dick

Crank Assy AB DICK
9800, To 9890
350, 360, 375, 385, 9910

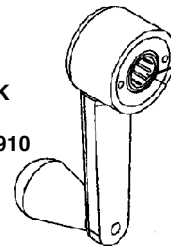

One Way Clutch Bearing

W-310	\$
A-17788	\$112.25

Table Release Lever Assembly

350, 360, 375, 385,	A-80150	\$192.60
9800	A-13827	\$160.70



Speed Control Shaft

For the 8800 & 9800 series

Shaft	A-98053	\$180.65
-------	---------	----------



Stock Retainer Plate Guide

350 & 360 Center Plate	A-36712	\$36.20
350 & 360 Right hand	A-36092	\$35.20
350, 360, 375, 9800, Left hand	A-36089	\$30.95
385 Back guide plate	A-36089	\$30.95

Back Paper Guide

	A-73467	\$12.75
--	---------	---------

Thumb Nut

	A-72292	\$7.15
--	---------	--------

Spring Guide

350, 360, 375	A-73472	\$30.95
385 Side	A-73472	\$96.20
385 Back	A-38090	\$96.20
Screw	A-984	\$0.75

Table Raise Gear & Ratchet Assy

For feeder hand crank no 350,360, 9800.

350, 360, 375. Complete

Ratchet Assy 32 Tooth	A-17644	\$249.20
Ratchet Assy 16 Tooth	A-80204	\$249.00



SHAFT PULLEY ASSEMBLY

350, 360, 385.	A-362080	\$57.40
375, 9800	A-372080	\$96.30

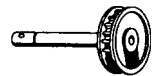

AB Dick Chain Delivery Gripper Chains

350, 360, 375, 9800 (OS) 385,		
Set of 2 (Old style 1/2 carrier link)	A-361100	\$192.50
Set of 2 (New style 5/8 carrier link)	A-361390	\$225.70
Set of 2 (New style 9800, 1 to 1 CD)	A-391390	\$
6" star wheels.		

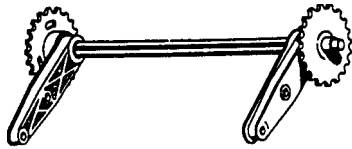

AB Dick Chain

Shaft & Sprocket Assembly

350, 360, 12-1/16" Inside sprocket to sprocket	A-361165	\$674.00
8810	A-881160	\$674.00
375, 9800, OS Standard	A-371160	\$674.00
9800 1 TO 1 NS	A-981160	\$410.00

INK FOUNTAIN CRANK

For use on 350, 360, 385, 9800.

Provides a steady even turn of the ink fountain roller. A-W-310



INK FOUNTAIN SEAL (Set of two)

fountain roller A-18360 \$10.00 \$5.00

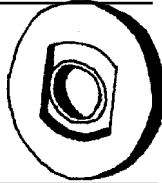

TIRE FOUNTAIN roll knobs

A-36244 \$6.35

TIRE Ink form roll knobs

A-36399 \$4.30



Single Lever Control Arm

360	Complete	A- 36856	\$130.00
9800	Complete	A- 98856	\$128.35
Knob		A- 36858	\$ 10.60

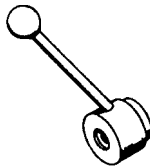

Ink Ductor Cam Kit For ink ductor

---Uses a bearing in place of the cam.

No 36500 \$13.80

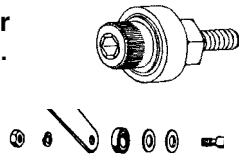

GAP CONTROL SHAFT ASSEMBLY



350, 360	Complete	A- 36689	\$187.00
375	Complete	A- 37689	\$235.30
9800 Imp. Cyl	Complete	A- 98689	\$116.45
9800 Master Cyl	Complete	A- 98693	\$273.75
350, 360, 375,	Dial Assy	A- 36688	\$110.00
8800, 9800	Dial Assy	A- 98688	\$110.00

QUOTE

There is always something to be thankful for
 If you cannot pay your bills, you can be
 thankful you're not one of your creditors



Control Panel Overlay & Membrane

(1) 9815, 9850	A-98540	\$229.95
(2) 9870	A-98560	\$

Drive & Pump Switch

Old style (drive & pump) 2 position with screw connectors A- 36977 \$37.35

(385) Momentary (3 position) with tab connectors. A- 38977 \$49.15

(New style) Motor momentary (3 position) with tab connectors A- 36303 \$34.00

(New style) Pump momentary (3 position) with tab connectors A- 36307 \$25.60

(New style) Pump momentary (2 position) with tab connectors A- 36305 \$14.60

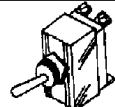
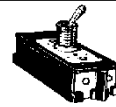

Blanket Cylinder Adjusting Shaft

350, 360, 375 A- 36236 \$50.20

9800 A- 98236 \$60.90

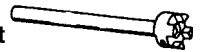

Tape Tracking

Made of "sand paper like" material that holds better for Star Wheels on 9800 1 to 1 chain deliveries

983130 \$2.10



AB DICK 360 / 369 / 375 / 380 / 385 / 9800 BLANKET BAR

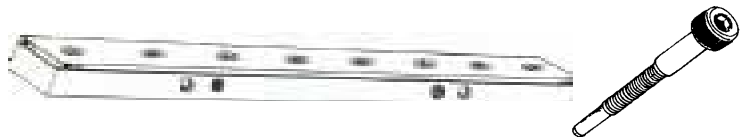

Complete Set 2 Tops & 2 Bottoms

A- 36252	360 / 390	\$102.00
A- 37352	375 / 9800	\$
A- 38252	380 / 382 / 385	\$145.00
A- 26204	Mounting Screw	\$ 0.75

Quick Change Blanket Bar

Save time · Change only 2 screws

- Quick & easy to use
- Complete with hardware
- All metal construction



P-36777	AB Dick 360	\$106.00
P-37777	AB Dick 375 & 9800	\$106.00

Shaft Assembly 350 & 360 (manual control Old style)

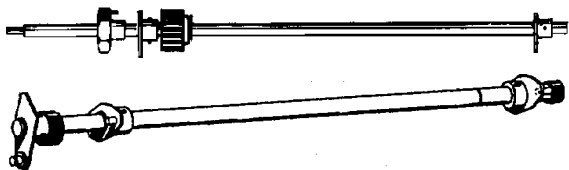

A- 36437 Shaft Assembly 350 & 360 (manual control) \$211.75
Night latch gear sold separate.

Single Lever 350, 360, 375 & 9800 (shaft assembly)

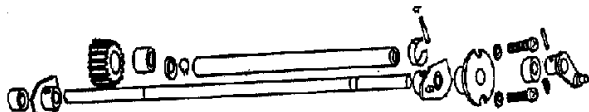

A- 36497 Single Lever 350 & 360 (shaft assembly) \$288.80
AB Dick 375 & 9800.

A- 37497 Single Lever 375 & 9800 (shaft assembly) \$288.00
Night latch gear sold separate.

(2)	A-36509	350 & 360 Tube	\$ 5.60
(2)	A-37509	375 & 9800 Tube	\$ 5.60
(3)	A-370	Kit Set of Two each	\$
(1)	A-661	C - Ring	\$ 0.75

NIGHT LATCH IDLER GEAR
IDLER GEAR
350, 360, 375, 9800.

A-6446	Brass (1)	\$ 51.40
A-36457	Steel (1)	\$ 102.00
A-36455	Nylon (1)	\$ 48.00

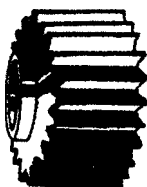

Go GET 'Em?.

Printing orders grow thick on trees or
Buzz around as thick as bees, you could
Sit right there in your swivel chair, hear
Your presses hum if jobs had legs and walked
Right in and greeted you with a pleasant
Grin you could sit right there in your swivel
Chair, but it is a hard degree of fact that
Printers hustle early and late so you better
Beware of that swivel chair for
Job aren't going to come right in

Change Blankets in 60 seconds.
Not an extra set." Bars remain on cylinder.
Available for; AB DICK , ITEK, RYOBI.

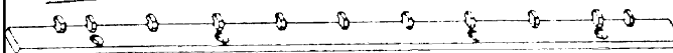
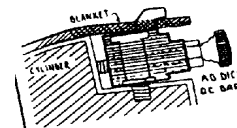
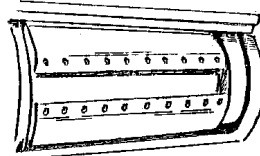

ORDER QUICK CHANGE BLANKET BARS

AB-335	Quick	360 / 390	\$
AB-336	Quick	375 / 9800	\$
AB-337	Quick	3985 / 3302M	\$

360 or 9800 Manuals
YOUR SOLUTION TO COSTLY DOWN TIME,
FRUSTRATING OPERATIONAL PROBLEMS,
MECHANICAL PROBLEMS & SERVICE CALLS.

The first professional book of it's kind. Simplified, easily understandable, step-by-step remedies for both operational and mechanical problems. Lavished throughout with precise detailed illustrations. A complete Pressman's Bible incorporating all the how-to for servicing, repairing and troubleshooting. Packed with enough information to rebuild your press.

(Can be ordered in Spanish)

A-1862	9800 Service Manual	\$
A-1001	360 Service Manual	\$

EMERGENCY " QUICK FIX KITS"

Imagine this - Your in the middle of a print job when suddenly a spring breaks or a loose retaining ring pops off. What do you do? With days for a simple part to arrive while your press set idle?

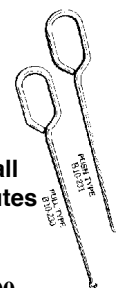
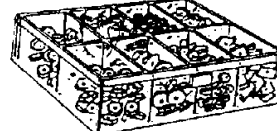

Just Keep One or More Kits on Hand at all Times and You'll Be up and Running in Minutes

AB DICK PARTS KIT.

A-1707	MASTER KIT	720 pcs	\$280.00
A-5088	JUNIOR KIT	437 pcs	\$134.95
A-1706	SPRING KIT	28 pcs	\$58.95

Have your Walmart girl pick you up a spring hook in the knitting section For \$2.50

Spring Hook Set I-600 \$7.50

This Place Requires no physical fitness program Everyone gets enough exercies jumping to conclusions.

AB Dick Water Bottle Assembly
350 ,360 PRO 375, 9800
380, 385 PRO

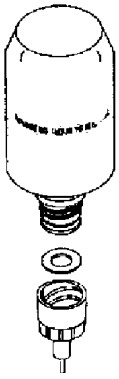

Bottle 360 AB-3500 \$41.00
Bottle 9800 AB-3500 \$41.00

Water Waver Roller Parts

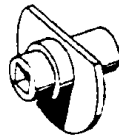

Coupling Housing For Water Waver Roller
A- 84413 \$56.70

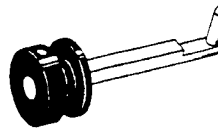

Coupling Assembly For Water Waver Roller
A- 73011 \$93.00



Ink Oscillating Shaft & Lever Assy
350, 360, 375, 9800
A-36462 \$136.85

Ryobi Fountain Roller (Soft Rubber)

Pressline Part No

Ryobi 2800/960

FACE

(1) R-2863-R 11-13/16 5290-53-320-1 \$

(1) R-3263-R 13-7/32 5320-53-350-1 \$

Chrome Roller Super Aquamatic

Pressline Part No

Ryobi 2800/960

(2) R-2815-PRO 5290-53-341 \$

Ryobi 3200 / 975 (2) 5320-53-341 \$



(1)	R- 53352-2	Shield (Set of Two)	\$
(1A)	R - 353	Parts Kit (Set of Two)	\$
(2)	R- 90201	Bearing Ea	\$
(3)	R-53153-2	Gear	\$
(4)	R- 53162-2	Housing (3)	\$
(5)	R- 43121	Washer (Set of 4)	\$

STANDARD AQUAMATIC WATER SYSTEM

AB Dick 350, 360, 9800, 375, 380 MGD, 385 MGD 22, 9880 PRO 22.

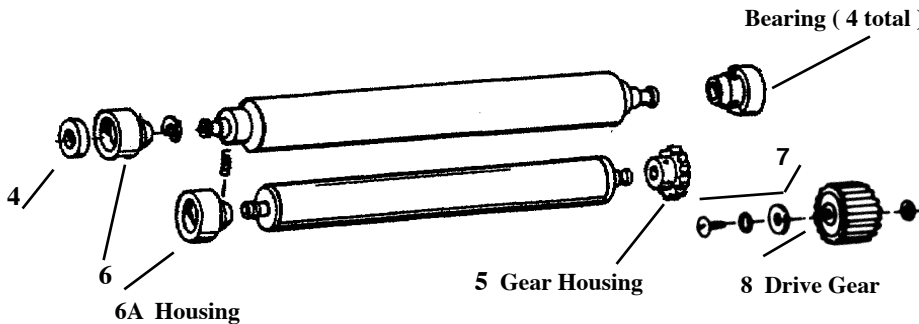

INK DUCTOR STUD & TRUCK



360 & 9800
A-190118 Stud \$30.00
190103 Cam Truck \$ 3.75

AB DICK STANDARD WATER PARTS.

350, 360, 9800.

(6)	A-80504	Housing (3)	\$46.00
(6A)	A-80591	Housing	\$46.00
(4)	A-80505	Bearing	\$10.60
(5)	A-80599	Gear Housing	\$77.20
(7)	A-354	Parts Kit	\$71.00
(8)	A-82050	Water Drive Gear	\$32.00

AB DICK STANDARD WATER PARTS.

380 MGD, 385 MGD 22, 9880 PRO 22.

(6)	A-80504	Housing	\$46.00
(6A)	A-80591	Housing	\$46.00
(4)	A-80505	Bearing	\$10.60
(5)	A-80599	Gear Housing	\$77.00
(7)	AB-354	Parts Kit	\$71.00
(8)	A-82050	Water Drive Gear	\$32.00



Chain Pressure Pad

A-81637	Pressure Pad	(LH)	\$26.67
A-81629	Pressure Pad	(RH)	\$26.67

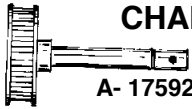

CHAIN TIMING PULLEY & BELT

A- 17592	CHAIN PULLEY	\$57.80
A- 194836	Belt	\$ 8.60

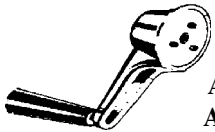

CHAIN CRANK ASSEMBLY

A-81705	Crank	\$ 167.60
A-36946	Pin	\$ 5.25

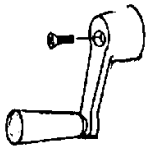

CRANK ASSEMBLY

71399	Crank	\$57.70
14284	Screw 10x32-7/16	\$ 0.42

CRANK SHAFT & GEAR

360 AB Dick



81605	SHAFT & GEAR Assy	\$127.00
9800		
17598	SHAFT & GEAR Assy	\$127.00

Lower Lamp Assemble 9800

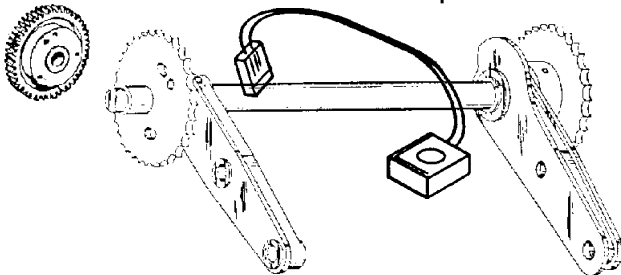

Lamp Assembly 9800

A- 11506	Photo Lamp Assy Lower	\$175.00
NEW STYLE (1 to 1) Drive 360, 375, 9800.		
16367	Main Shaft Assy	\$410.00
Bushing New Style (One)		
A-14608	Bushing	\$ 3.85
New STYLE. Drive Gear 9800,375		
A-16374	Drive Gear (1 to 1)	\$286.55
Old Style 350, 360		
78304	Main Shaft Assy	\$ 674.00
Old Style 375, 9800		
7722	Main Shaft Assy	\$ 647.00
AB Dick (M.G.D) & 385		
381160	Main Shaft Assy	\$1,264.60
Bushing Old Style		
14641	Bushing	\$ 4.50
Drive Gear Old Style		
A-78489	(3/8 Hub)	\$ 278.20
A-362560	(1/4 Hub)	\$ 436.29

QUOTE Printing with T-51
Color head when I sold a
new



BACK STOP SPRING

Made with spring steel & nickel plating which prevents cracking & adds better spring action & durability.

- Complete with cam. 350, 366, 375, 385, 81846 Complete \$64.10
- Complete with cam. 9800 17577 Complete \$ 86.00

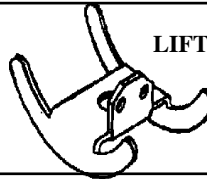

LIFT GATE CAM & COLLAR ASSEMBLY

• 350, 360, 375.

A-362280	Gate	\$53.40
A-81850	• 375, 9800	\$53.40

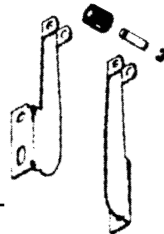

ARMS For 9800 1 to 1 chain delivery safety guards.

Complete Assembly.

A-984289	Operators side	\$36.30
A-984279	Non-OPERA side	\$36.40

STOP OFFSETTING!
Leave the Printed Job on
A Spare Dolly or Two

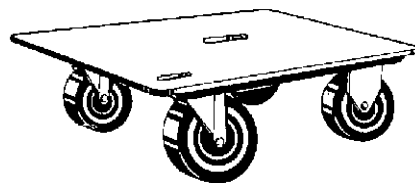

A-362440	350, 360 Series	\$427.00
A-372440	375 Series	\$224.00
16389	9800 Series	\$320.00
A-382440	385 Series	\$427.00

IDLER SHAFT ASSEMBLY

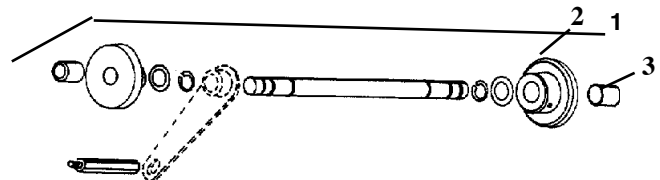

9800, Assembly

(1)	7720	Roller Shaft Assy	\$399.90
-----	------	-------------------	----------

350, 360 Assembly

(1)	78495	Roller Shaft Assy	\$378.30
(2)	81660	Roller	\$116.55
(3)	14608	Bushing	\$ 3.85

Tip Never remove old chain from press just Fasten the new chain to the old chain and rolling Press around disconnect old chain, fasten new Chain you're have to loosen up the adjustment on the side of the press. If you need a sample for chain links don't for get to put white out on The drive gear only remove one chain at a time.

Chains cannot be purchase separately must be in a set of 2



350, 360, 375, 385 Chain Set of Two
A-78485 5/8 Link set of two. \$225.00

360, 375, 385, 9800 one to one Chain Set of Two
A-16381 set of two. \$104.00

AB DICK GRIPPER BAR ASSEMBLY
Made with steel which prevents bowing.

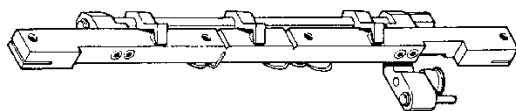

- 350, 360, Gripper Bar Assembly
- (1) 73930Bar Assembly \$368.00
- 375, 9800, Old Style Grippe Bar Assy.
- (1) 16690Bar Assembly \$302.75
- 9800 1 to 1 CHAIN DEL.
- (1) 16690Bar Assembly \$302.75
- 385, Gripper Bar Assembly.
- (1) 385990Bar Assembly. \$



A penetrating dry lubricant that protects & lubricates and disperses water. An ideal lubricant for plate Clamp & Water unit, Gears, and Chain.

G-120 Chain Lubricant & Protector (No AMP) \$

AB DICK GRIPPER
Diamond Coated Gripper Fingers

Diamond Coated Gripper gives your AB Dick a much needed paper grip, improves register. On all type of paper stock.

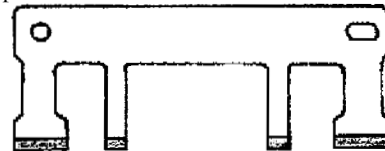

- 9805 / 9800
- A-7984-D Paper Stop Kit (3) \$
- 350 / 360
- A-78608-D Paper Stop Kit (2) \$

AB DICK GRIPPER BAR PARTS

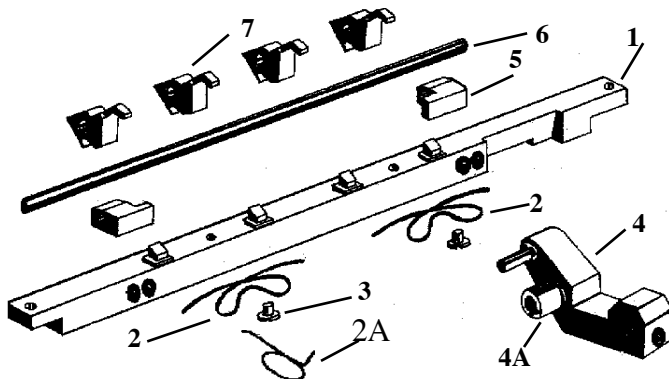

- | | | | |
|------|----------|----------------------|-----------|
| (1) | A-73932 | Bar 350, 350..... | \$139.00 |
| (1) | A-16691 | Bar 375, 9800..... | \$101.55 |
| (2) | A-80218 | Spring 350, 360 (1) | \$ 2.00 |
| (2A) | A-73934 | Spring 350, 360. | \$ 3.25 |
| (2) | A-7982 | 375, 9800, Spring | \$ 2.00 |
| (3) | A-41750 | Screw Shoulder | \$ 6.90 |
| (4) | A-361040 | 350, 360, Cam Lever | \$ 69.45 |
| (4) | A-381040 | 375, 9800 Cam Lever | \$ 48.00 |
| (4A) | A-73064 | Truck | \$ 9.65 |
| (4A) | A-14504 | C-Ring..... | \$.75 |
| (4A) | A-80564 | Stud For Cam..... | \$.75 |
| (5) | A-81764 | Brass Bearing | \$ 32.10 |
| (6) | A-71585 | Shaft 350, 360 | \$ 53.40 |
| (6) | A-7727 | Shaft 375, 9800 | \$ 111.65 |
| (7) | A-81762 | Gripper | \$ 11.80 |
| (7A) | A-14576 | Pin (4) | \$.75 |

AB DICK IMPRESSION GRIPPER



(1) 9800 Paper Gripper

- 9805 / 9800
- A-7986 Paper Gripper (1) \$19.00
- 350 / 360
- A-78608 Paper Gripper \$20.90

Gripper Impression Cylinder Paper Stop.



- 9805 / 9800
- A-7984 Paper Stop \$149.75
- 350 / 360
- A-78608 Paper Stop \$79.00

AB DICK INK FOUNTAIN ROLLERS

350,360,8800,9800,to 9870,385,9880, 9890

Old Ink Fountain Blade Should Be Replaced, When New Ink Fountain Roller Is Installed (Page 30)



AB Dick Fountain Roller (Hard Rubber Surface)

Pressline Part No	Roll Dia	Roll FACE	Overall Length	Part No	Price
AB Dick 350, Old Model				76021	
(1) 73823	1-1/4	10-17/32	19-1/4	73823	\$
AB Dick 350, 360, 360-PRO, 8800				76021	
(1) 76021	1-1/4	11-1/32	19-1/4	76021	\$
AB Dick 375, 9800 Series				7588	
(1) 7588 (OS)	1-1/4	13-1/16	21-1/4	7588	\$
(1) A-37536 (rubber seals)	1-1/4	12-3/4	14-13/32	18358	\$

AB Dick 380, 385, 385 PRO (Not Available)



Roll Pin No 14921(FIVE) \$

AB Dick Fountain Roller (With Steel End Bands)

Pressline Part No	Roll Dia	Roll FACE	Overall Length	Part No	Price
AB Dick 350.				73823	
(1) AB-3505	1-1/4	10-1/2	19-1/4	73823	\$
(1) AB-3605-A	1-1/4	11	19-1/4	76179	\$101.00
AB Dick 350, 360, 360-PRO, 8800				76179	
(1) A-3605-A	1-1/4	11	19-1/4	76179	\$101.00

9800 INK ROLLER

AB Dick (9800 series/split shaft)

(1) AB-3705-B	1-1/4	11	19-1/4	76021	\$156.95
---------------	-------	----	--------	-------	----------

AB Dick 375, 9800 Series.

(1) AB-3705-A (OS)	1-1/4	13	21-1/4	7588	\$
--------------------	-------	----	--------	------	----

AB Dick (9800 series/split shaft)

(1) A-3705-B	1-1/4	12-3/4	14-13/32	18358	\$156.95
--------------	-------	--------	----------	-------	----------

Ink & Water Fountain Crank

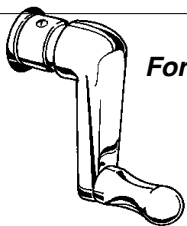

For use on AB Dick 350, 360.9800.380,385.

QUICK, EASY INSTALLATION

A- W-310 \$

FAST OPERATION -This L-O-R Ink Fountain Crank provides a steady even turning of the ink fountain roller for quick job setups or fast recovery of ink while press is running.

MIXING OF INK - Adding and mixing of driers, varnish, reducers, etc., to ink right in the fountain is quick and easy.

RATCHET EXTENSION

Shaft end for 9800 AB

1• A-18369 Crank	\$139.00
1• A-18366 Knob	\$ 95.25
2• A-80630 360 PR Pawl	\$ 50.20
2• A-17693 9800 Pawl	\$ 50.20
3• A-80634 Spring	\$ 3.40

β3• A-1046 Ring \$

INK ROLLER SEAL (set of two)

A-18360 \$

When Replacing Ink fountain Roller
A Worn Ink fountain Blade.

May Cause Leakage On The Sides.

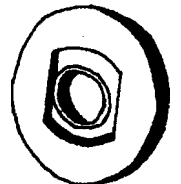
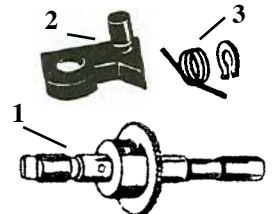

AB DICK ROLLERS & PARTS

350,360,880,9800, to 9870,385,9880 9890

Complete with precision gears for smooth quiet operation Our special HARD rubber is compression molded onto a skillfully machined new steel core to create an unbreakable bond between the rubber and metal. Uniform rubber grinding yields the optimum velvet finish required for accurate ink milling.

Geared Ink Intermediate Roller (ASSEMBLY) (Schematic numbers "04" and "52")

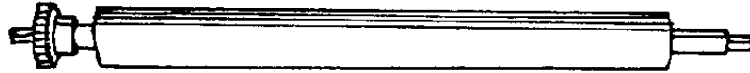

Pressline Part No	Roll Dia	Overall FACE	Part Length	Part No	
AB Dick 350					
(1) A-35029	1-1/8	10	14-1/8	76199	\$
AB Dick 360, 360-PRO, 8800					
(1) AB-3604	1-1/8	10-7/8	14-1/8	76199	\$60.65
AB Dick 375, 9800 Series.					
(1) AB-3704	1-1/8	12-7/8	16-1/8	7549	\$69.45
AB Dick 380, 385, PRO (Not Available)					



GEARED MAIN OSCILLATOR ROLLER

Pressline Part No	Roll Dia	Overall FACE	Part Length	Part No	
AB Dick 350					
(1) A-350830	2-1/2	10-25/32	19-1/16	71527	\$
AB Dick 360, 360-PRO, 8800					
(1) AB-3655	2-1/2	11-5/32	19-1/16	71507	\$207.45
AB Dick 375, 9800 Series					
(1) AB-3755	2-1/2	13-5/32	21-1/32	7556	\$235.00
AB Dick 380, 385, PRO (Not Available)					

AB DICK INK DUCTOR ASSEMBLY & PARTS (360) (9800) (385)

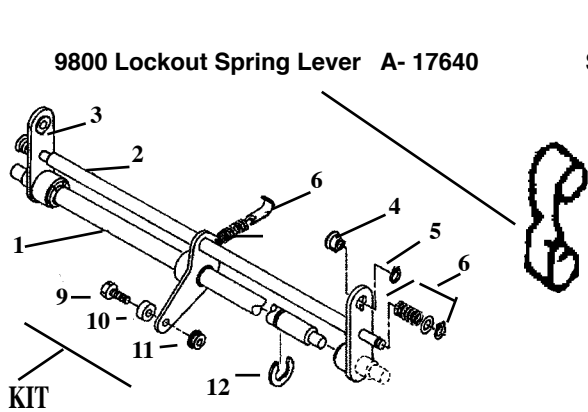

9800 Lockout Spring Lever A- 17640 \$9.00

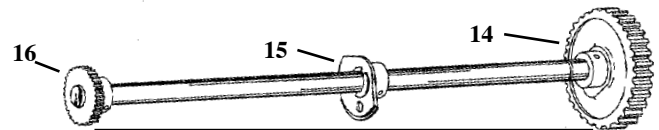

AB Dick 360, 8800.

(1)	A-76670	360 Shaft Assy	\$114.50
(2)	A-73061	360 Bar	\$ 50.20
AB Dick 9800 Series			
(1)	A-17633	9800 Shaft Assy	\$229.95
(2)	A-16937	9800 Bar	\$ 28.80
(3)	A-84422	Lever Assy	\$ 10.00
(4)	A-84421	Bushing	\$ 10.00
(5)	A-1047	Ring Ret.	\$ 0.75

WHY SOME PRINTERS GROW-

Your business expands when you or your salesman enjoy selling advantage. Many of the largest printing concerns have the best Digital printers & offset and bindery equipment the salesman lose view orders because they can advise without prejudice how a Piece should be produced and when savings can be affected by one of the three processes The customer benefits. Perhaps the hardest job your salesman have is to make the business thing not so much what good Printing IS as to what it DOES, Such salesman are welcome wherever they go. Their customers outnumber their prospects their firm grows year after year.

FEED ROLLER ASSEMBLY



DOUBLE KNURLED LOWER FEED ROLLER
UPPER FEED ROLLER

(1)	AB-3600-8	360 & 360 (71551)	\$87.50
(1)	AB-3700-A	375 & 9800 (7641)	\$94.20
(1)	A-38157	385	\$
(2)	A-64846	Plastic Bearing	\$ 6.85
(3)	A-74400	Bearing Segment	\$26.00
AB Dick 350 & 360			
(4)	A-36147	Lever Assembly	\$246.00
AB Dick 375 & 9800			
(4)	A-37147	Lever Assembly	\$246.00
(5)	A-50435	Spring	\$ 1.30
(6)	A-50435	Spring	\$ 1.30
AB Dick 350 & 360			
(7)	A-72120	Roller Assembly	\$385.00
AB Dick 375 & 9800			
(7)	A-7647	Roller Assembly	\$385.00

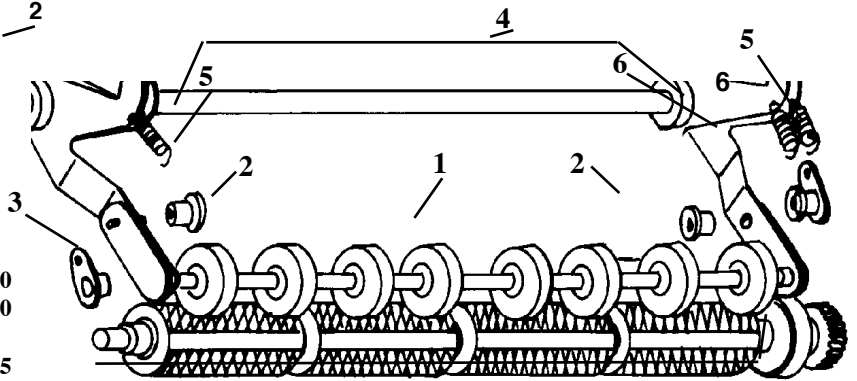

9800 Paper Sensor

Has six month warranty
9800 Paper Sensor

A-9532	Sensor Assy	\$76.00
A-9535	Spring	\$ 8.60

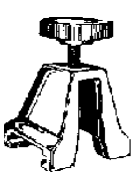

1
ADJUSTING CLAMP

(1)	A-36087-A	Clamp Assembly	\$29.90
-----	-----------	----------------	---------

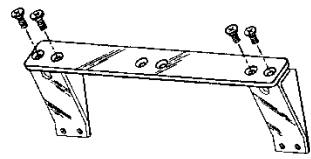

GUIDE PLATE

(1)	A-73469	Plate	\$30.95
(2)	A-73472	Spring Guide	\$30.95
(3)	A-14225	Screw	\$ 0.75

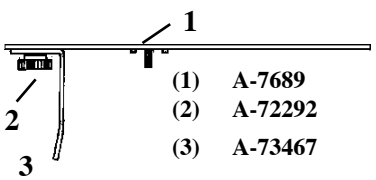

1
CENTER PLATE

(1)	A-7689	Plate	\$39.50
(2)	A-72292	Nut	\$ 8.45
(3)	A-73467	Back Guide	\$12.75

FINGER ASSEMBLY & BLOWER TUBE

A-72143	350, 360, 375, 9800	\$101.55
A-38158	385, 9880, MGD	\$256.60

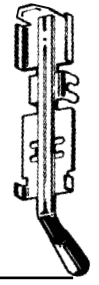

BAIL BAR PAPER WEIGHT

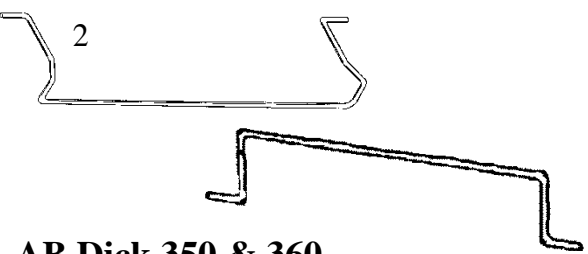

AB Dick 350 & 360

(1)	A-78429	Regular Weight	\$19.25
(2)	A-74652	Light Weight	\$21.50

AB Dick 375 & 9800

(1)	A-7661	Regular Weight	\$13.50
(2)	A-7809	Light Weight	\$17.95

AB DICK COUNTER ASSEMBLY AB DICK COUNTER ASSEMBLY

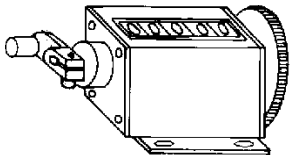

A-72426	350, 360 375 COUNTER	\$213.90
A-72426	9800, 9810 COUNTER	\$
A-10166	9800 Counter Rod	

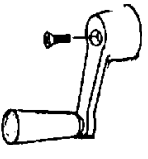

CRANK ASSEMBLY

A-71399	360 Crank	\$57.70
A-17595		

INK FOUNTAIN BLADE SCREW



A-73512	1-1/4" Adjusting Screw	\$7.90
A-77426	2-1/4" Adjusting Screw	\$9.55

Ink Fountain Blade

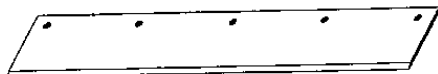

AB Dick 360, 360 PRO

A-76402	1-3/4" Wide	\$ 96.25
A-10153	2-7/8" Wide	\$125.00

AB Dick 375, 9800, 9800 PRO

A-7596	1-3/4" Wide	\$ 96.25
A-8066	2-7/8" Wide	\$273.00

AB Dick 385 Standard Width

A-80166		\$160.65
---------	--	----------

AB DICK INK FOUNTAIN ASSEMBLY Designed With Replaceable Steel" End Caps & Deeper Ink Well For 50% More Ink Capacity.

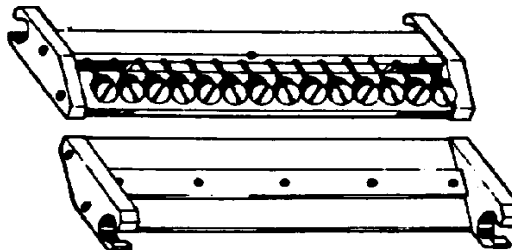

AB Dick 350 Old Style Fountain

A-73100	Complete Assy	\$667.75
A-73101	Fountain Only	\$470.00
A-36084	Wire	\$ 1.25

AB Dick 360, 360 PRO

A-76037	Fountain Assy (old style)	\$492.25
A-10150	Fountain Assy (split shaft 2-7/8)	\$492.25
A-76402	Fountain Only	\$
A-76040	Wire	\$ 1.25

AB Dick for 375 & 9800

A-17123	Complete Assy (old style)	\$534.95
A-18350	Fountain Assy (split shaft 2-7/8)	\$585.00
	Fountain Only	\$
A-7594	Wire	\$ 1.25

AB Dick RUBBER SUCKERS

Standard Regular Suckers

AB-374-1	(1 Dozen)	\$ 5.00
AB-375-5	(5 Dozen)	\$24.00



Thick Longer Wearing Suckers

AB-771-1	(1 Dozen)	\$
AB-777-5	(5 Dozen)	\$

COMPENSATING SUCKER FEET



A.B. DICK

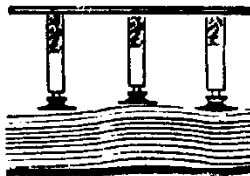

• Spring loaded foot corrects for uneven paper height. Curly, wavy, wrong grain direction paper are automatically compensated for. Change from 8 1/2" x 11" to 11" x 17" to envelope in seconds. Just shut off the unwanted sucker tubes. Put them on and leave them on.

P-36966-1	Set of One	\$ 40.55
P-36966-3	Set of Three	\$112.00
P-36966-9	Set of Nine	\$310.00

STANDARD SUCKER TUBES.

(SET OF ONE)

AB-80220	1	\$ 9.90
350, & 360 AB Dick		
AB- 80220	(Set of 9)	\$85.00
375 & 9800 AB Dick		
AB-80220	(Set of 11)	\$94.45



SUCKER TUBES With Shut Of Valve.

P-36990-1	Set of One	\$ 9.90
P-36990-3	Set of Three	\$28.35
P-36990-9	Set of Nine	\$83.25

BIG FOOT SUCKER TUBES

A spring-loaded vacuum controlled piston (just like the Big Boys). Big Foot retracts and stays that way till the sheet is in-fed, then goes for the next one and you get perfect separation every time using Big Foot and Big Foot uses AB Dick rubber suckers. Available for Most Offset presses.

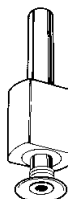
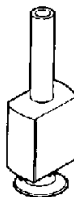

AB-370-1	Set of One	\$
AB-370-3	Set of Three	\$
AB-370-9	Set of Nine	\$

TABLE RAISE HANDLE ASSEMBLY
 Made with durable solid brass with 3 pins for longer wear.

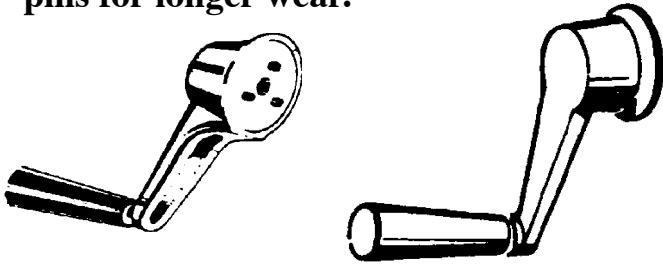

- | | | | |
|---------------------|---------|--------------------------|----------|
| 1. | A-36955 | Table Crank (350, 360) | \$134.00 |
| 2. | A-17803 | Table Crank (385, 9800) | \$ 81.90 |
| A-17714 Chain Crank | | | \$167.70 |

FEED TABLE RAISING SHAFT

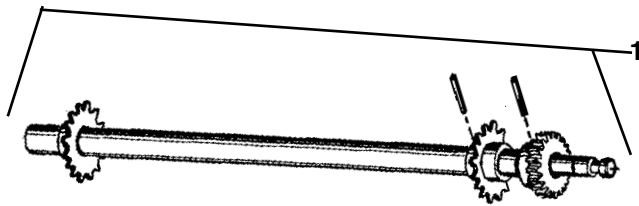

- | | | | |
|----|----------|-----------------|----------|
| 1. | A- 17151 | 9800 Shaft Assy | \$337.00 |
| 1. | A- 72624 | 360 Shaft Assy | \$395.80 |

POWER LINK, FEED MECHANISM & TABLE RELEASE LEVER.

- | | | | |
|-----|---------|------------------------|----------|
| 1. | A-72504 | Lever Assembly | \$199.90 |
| 2. | A-1472 | Bushing | \$ 3.10 |
| 2. | A-1095 | .227 I.D X .027 C Ring | \$ 0.75 |
| 3. | A-36327 | Spring | \$ 2.60 |
| 4. | A-72504 | Arm Assembly | \$199.90 |
| 5. | A-1469 | Bushing | \$ 2.50 |
| 6. | A-72512 | Spring | \$ 2.80 |
| 7. | A-73381 | Spring | \$ 3.10 |
| 8. | A-72589 | Power Link Assembly | \$307.00 |
| 9. | A-1472 | Bushing | \$ 3.10 |
| 9. | A-1095 | C Ring .245 I.D. X 500 | \$ 0.75 |
| 10. | A-41777 | Spring | \$ 2.80 |

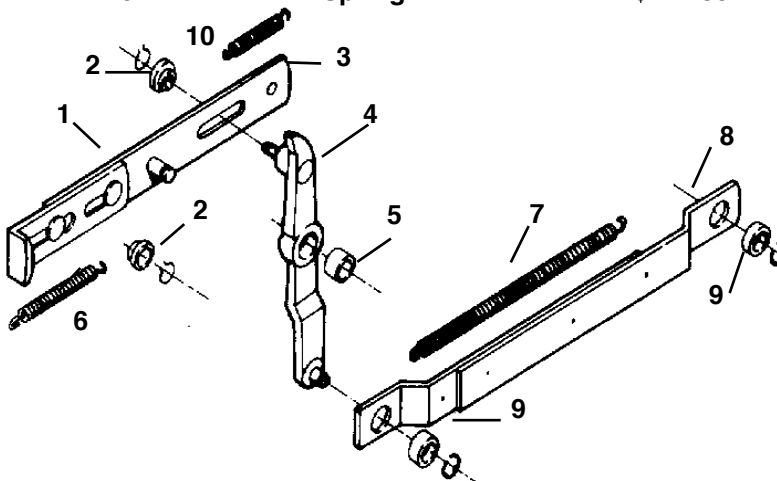

The **Cool Cat Lamp** provides soft comfortable light on work area, eliminating shadows and light-inadequacy. The vital "eye-link" is a safeguard, preventing eyestrain, errors and paper waste.

The simplicity and versatility of the **Cool Cat Lamp** are provided by the rigidly constructed, steel wrapped flexible arm and 180° rotation of the lamp on an ingenious twist fitting or an up and down movement of our limited swivel.

79147 Lamp \$

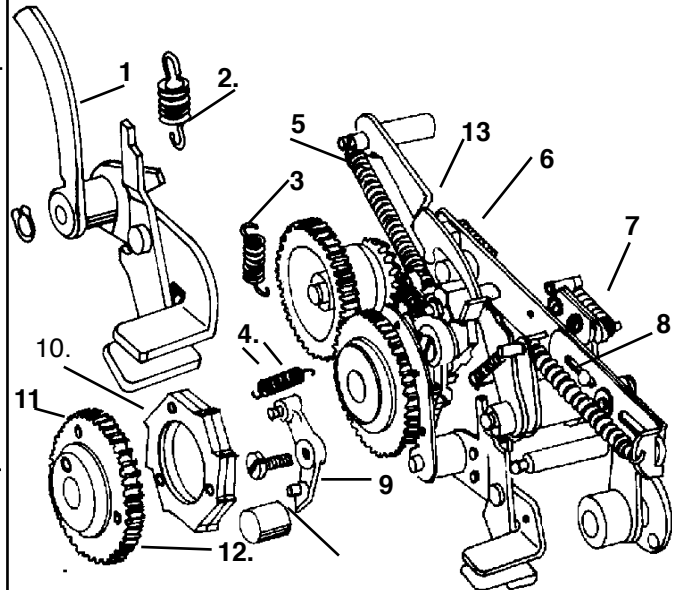
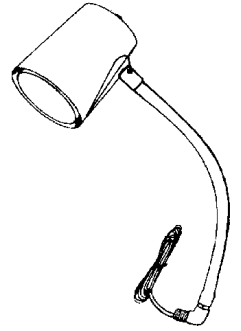

- | | | | |
|-----|---------|---------------------------|----------|
| 1 | A-80150 | Release Lever (350, 360) | \$192.90 |
| 1 | A-13827 | Release Lever (975, 9800) | \$160.50 |
| 2 | A-41291 | Spring | \$ 3.10 |
| 3. | A-41291 | Spring | \$ 3.10 |
| 4. | A-64590 | Spring | \$ 4.20 |
| 5. | A-72544 | Spring | \$ 3.10 |
| 6. | A-41777 | Spring | \$ 4.55 |
| 7. | A-73333 | Spring | \$ 3.00 |
| 8. | A-72512 | Spring | \$ 2.60 |
| 9. | A-17647 | Pawl | \$ 30.95 |
| 10. | A-36973 | Ratchet (350, 360) | \$109.00 |
| 10. | A-98973 | Ratchet (375, 9800) | \$ 30.95 |
| 11. | A-80144 | Gear | \$183.95 |
| 12. | A-80204 | Gear & Ratchet (350,360) | \$249.25 |
| 12. | A-17644 | Gear & Ratchet (375,9800) | \$249.25 |
| 13 | A-36944 | (OS) Stop Latches | \$ |

STOP LATCHES 360 & 9800.

- | | | |
|---------|--------------|----------|
| A-17643 | First Design | \$ 23.95 |
| A-75836 | Paw 9800 | \$ 30.95 |

First Design

9800

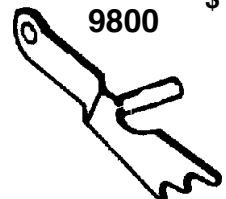

AB DICK WEB PARTS LIST NEW & USED

AB DICK DRIVE SHAFT

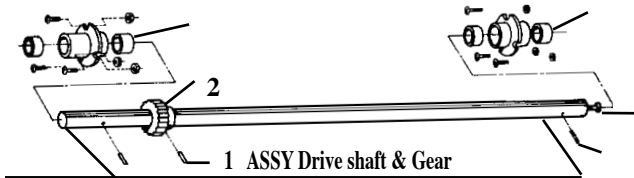

AB Dick 350 & 360 Drive Shaft Assy

- | | | | |
|-----|---------|-----------------------|----------|
| (1) | A-72672 | Assy (1, 2, 3, 4) | \$128.35 |
| (1) | A-37577 | 375 Assy (1, 2, 3, 4) | \$145.35 |

AB Dick 9800, Drive Shaft Assy

- | | | | |
|-----|------------|-------------------------------|----------|
| (1) | A-98577-65 | 1/2 Diameter Assy (9865/9869) | \$263.00 |
| (1) | A-98577-70 | 5/8 Diameter Assy (AB 9870) | \$238.90 |

AB Dick 20, & 22, Drive Shaft Assy

- | | | | |
|-----|---------|-------------------|----------|
| (1) | A-80243 | Assy (1, 2, 3, 4) | \$106.95 |
|-----|---------|-------------------|----------|

AB Dick 350 & 360 Drive Gear Only Sold With New Roll Pin

- | | | | |
|-----|----------|------------|---------|
| (2) | No 72669 | Drive Gear | \$74.80 |
|-----|----------|------------|---------|

AB Dick 375, 9800,

- | | | | |
|-----|---------|----------------------|---------|
| (2) | A-80191 | Drive Gear 5/8 Shaft | \$74.80 |
| (2) | A-72669 | Drive Gear 1/2 Shaft | \$74.80 |

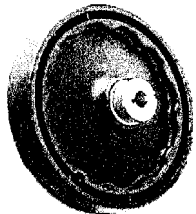

AB DICK HAND WHEEL 350, 360, 375, 8805, 8810. Longer lasting steel hub Better GRIP

- | | | |
|-------|---------------------|----------|
| 72640 | 360, 375 Hand wheel | \$133.65 |
| 16907 | 9800 Hand wheel | \$137.00 |

- | | | |
|----------|---------------------------------|--------|
| A-101333 | Hand wheel Roll Pin (Kit of 5) | \$4.00 |
| | Roll Pin 136 O. D. X 947 O.A.L. | |

QPC & PRO HOUSING ASSEMBLY Clutch Assy and Drive Shaft

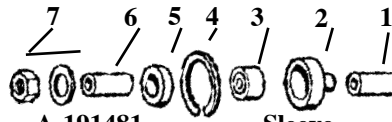

- | | | | |
|-----|----------|-------------|---------|
| (1) | A-191481 | Sleeve | \$ 5.25 |
| (2) | A-80522 | Housing | \$96.20 |
| (3) | A-190179 | Bearing | \$12.75 |
| (4) | A-100646 | C- Ring | \$ 1.00 |
| (5) | A-79866 | Spacer | \$10.75 |
| (6) | A-79865 | Sleeve | \$53.50 |
| (7) | A-196221 | Nut 1/2- 20 | \$ 8.45 |

CLUTCH PULLEY ASSEMBLY 350, 360, 375, 9800

TIP
Clutch Spring Brake Look
at Link Wear (3)

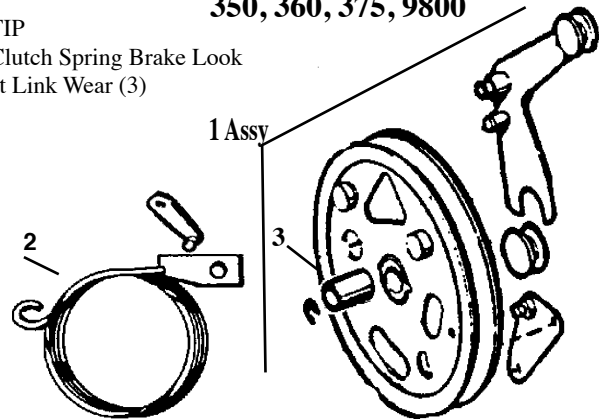

AB Dick Clutch Assembly.
360, 375, 9800.

- | | | |
|--|---------|----------|
| Complete hub I.D. 1/2" | A-36597 | \$270.00 |
| 9800 QPC, PRO | | |
| Complete hub I.D. 5/8" | A-98597 | \$230.00 |
| Oversized Clutch Pulley for slower speed control | | |
| No -36589 8" Dia (1/2 Belt 53") | | \$430.00 |

- | | | | |
|-----|---------|---------------|---------|
| (2) | A-73488 | Clutch Spring | \$13.00 |
| (3) | A-1473 | Bushing | \$ 2.50 |

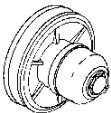

DRIVE PULLEY-VARIABLE 350, 360, 375 Sleeve

- | | | |
|---|----------------------------|----------|
| A-1631 | 49" (For chute delivery) | \$256.80 |
| A-1630 | 50" (For chain delivery) | \$156.00 |
| A-1631 | 53" (For 8" pulley) | \$256.80 |
| A-1632 | 51" (For 230v 50 HZ motor) | \$163.60 |
| Sleeve Needed if Motor Has 1/2" Dia Shaft | | |
| A-36007 | Sleeve | \$ 13.60 |



DRIVE PULLEY - VARIABLE 9810, 9850

- | | | |
|--------|-------------------------------|----------|
| A-1630 | (3/8 belt For chain delivery) | \$156.00 |
| A-1632 | (3/8 belt For chute delivery) | \$163.60 |
| A-1751 | 51" (1/2 belt old design) | \$582.00 |

DRIVE BELT 350, 360, 375

- | | | |
|--------|----------------------------|---------|
| A-1690 | 49" (For chute delivery) | \$12.60 |
| A-1691 | 50" (For chain delivery) | \$14.80 |
| A-1693 | 53" (For 8" pulley) | \$21.50 |
| A-1692 | 51" (For 230v 50 HZ motor) | \$12.90 |

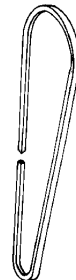

DRIVE BELTS

9810, 9850.

- | | | |
|--------|-----------------------------------|---------|
| A-1692 | (4L - 51" For chain delivery PRO) | \$12.90 |
| A-1691 | (4L - 50" For chute delivery) | \$14.90 |
| A-1692 | (3L - 50" For 230v 50 HZ motor) | \$12.90 |
| A-1693 | 53" (For 8" pulley) | \$21.90 |

Variable Speed Pulley For Drive Motor

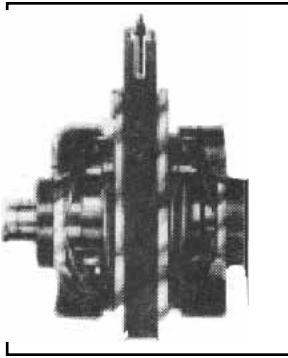

Additional Bearing Support

The peripheral support of the cam followers reduce pressure on the sliding face bearing surface.

The necessity of torque carrying keys in the pulley shaft and face are Eliminated, resulting in bearing surface.

Maintenance Free Bearings.

Not merely oil impregnated, our precision fit bronze bushing have an exclusively Formulated impregnation which virtually eliminated most fitting and corrosion Wear problems..

IMPORTANT TO ORDER

(Remember before ordering to measure motor shaft size)

9800 DRIVE PULLEY PART
Complete Cradle Repair Kit
No 98037

\$

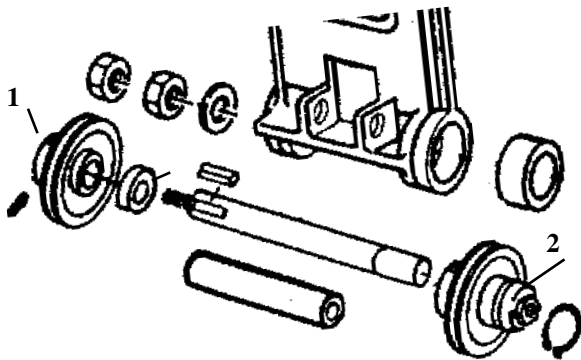

Kit	No 98037 Complete Cradle Repair Kit	\$114.95
(1)	A-196123 Pulley	\$ 37.45
(2)	A-79073 Pulley Variable Speed	\$174.90

CHAIN DELIVERY ROLLER IDLER GEAR
350/360/9800
A-78492

\$175.90

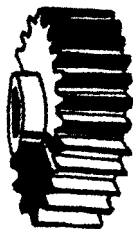

CAM SHAFT IDLER GEAR

9805/9800/CD	
A-78450	\$146.00
350/360/Chute	
A-72336	\$160.00

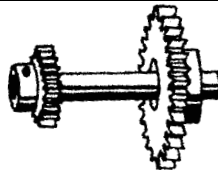

Gear wear can cause paper feed problems

MASTER CYLINDER DUCTOR GEAR

360 /	
A-78909	\$279.95
9800	
A-80910	\$331.70

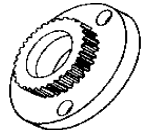

MASTER CYLINDER GEAR

350/360	
A-78908	\$365.75

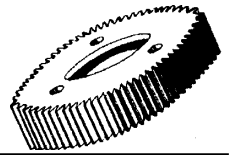

BLANKET CYLINDER GEAR

(Inner)	
350/360	
A-78415	\$427.95

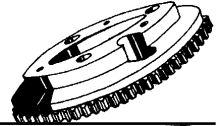

BLANKET CYLINDER GEAR

(Outer)	
350/360	
A-78554	\$785.95

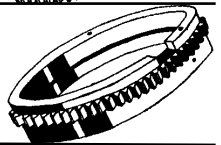

MASTER CYLINDER GEAR

9800	
A-9791	\$384.95

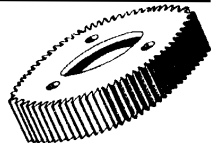

BLANKET CYLINDER GEAR

(Inner) 9800	
A-9554	\$427.95

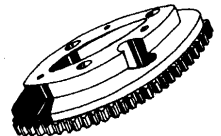

BLANKET CYLINDER GEAR

(Outer) 9800	
A-9548	\$495.95

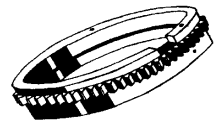

IMPRESSION CYLINDER GEAR

350/360/9800	
A-78711	\$363.75

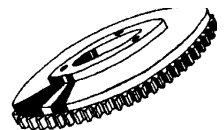

BLANKET CYLINDER
INDICATOR



1	A-78553	Scale	\$8.95
2	A-78552	Ind	\$4.50
3	A-14570	Pin	\$0.75

PAPER FEED RAISE GEAR

350/360/9800	
A-80144	\$185.95

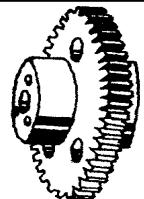

AB DICK REPLACEMENT GEARS
Pressline Recondition Kit, A quick, economical way to Rebuild your AB Dick The Box Contains Gears, Bushing, Bearing, Spring, Belts, and Rollers.

AB DICK DRIVE & PUMP SWITCH

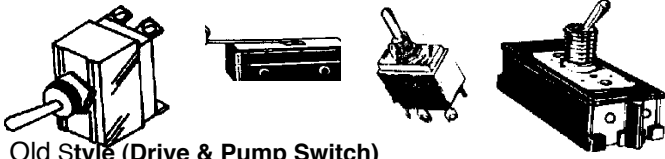

Old Style (Drive & Pump Switch)		
2# position with screw connectors	A 55238	\$37.75
Old Style (Motor)		
3# position with tab connectors	A-250865	\$34.90
New Style Drive (Motor)		
3# position with tab connectors	A-250999	\$26.95
New Style (Pump)		
2# position with tab connectors	A-250103	\$15.95
Micro switch chain deliver safety	A-60734	\$49.50

AB DICK EJECTOR ROLLER

AB DICK 350, 360, 9800

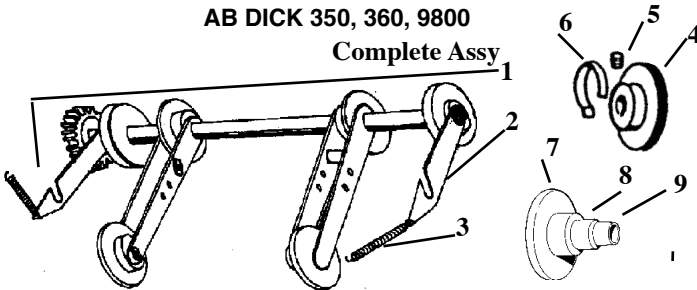

AB DICK 360, 360, 9800.

(1) A-36616	(360) Complete Assy	\$
(1) A-8290	(9800) Complete Assy	\$
(2) A-36584	Arm Operator Side	\$
(2) A-36586	Arm Non Operator Side	\$
(3) A-36604	Tension Spring	\$ 2.95
(4) A-13287	Upper Adjustable Roller	\$
(5) A-77236	Roller Plug (5/16)	\$ 4.25
(5) A-1507	Roller Plug (3/8)	\$ 4.25
(6) A-77117	Cap	\$ 8.25
(7) A-76362	Lower Roller	\$
(8) A-72343	Bearing	\$15.95
(9) A-77235	Roller Sleeve	\$ 5.85

UPDATE OLD EJECTOR ROLLER TO GEAR EJECTOR

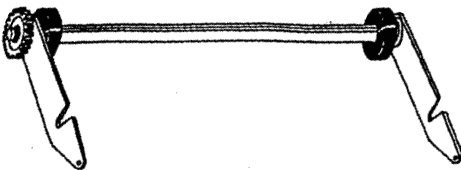

(1) A-36582	360 Gear Ejector Assy	\$320.95
(1) A-8290	9800 Gear Ejector Assy	\$320.95

Paper problems

Sheets that are cut with a dull blade show a tendency to stick together. The suction feed and the blower may not be able to separate sheets as a result of this the feed will miss feed or jam. There's a whole list of feeding problems trace back to the paper cutter and Paper cut wrong.



AB DICK 9800
A-10089 Control Cable \$189.85

AB DICK TAIL CLAMP ASSEMBLY

360 & 9800

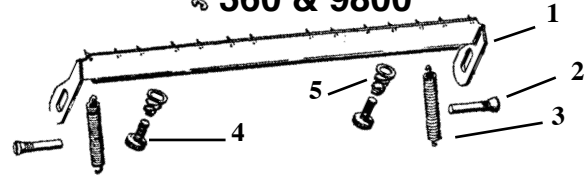

(1) A-36323	Tail Clamp 360	\$152.95
(1) A-37323	Tail Clamp 375	\$152.90
(1) A-9774	Tail Clamp 9800 ..	\$168.95
(2) A-36331	Pivot Screw	\$ 10.95
Aero Kroil Penetrating Oil		\$
(3) A-36327	360 Spring (Set of two)	\$ 5.60
(3) A-190137	9800 Spring (Set of two)	\$ 7.95
(4) A-1027-K	360 Adj. Screw	\$ 5.00
(5) A-192997	360 Spring Set of Two	\$ 2.95
(5) A-192997	9800 Spring Set of Two	\$ 2.95

AB DICK PLATE CLAMP ASSEMBLY

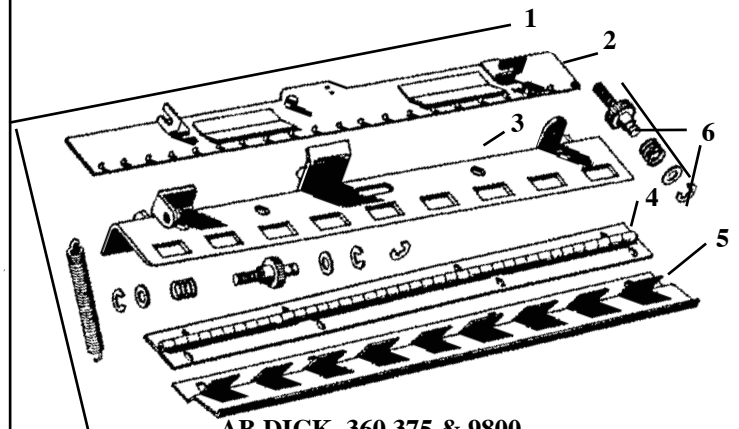

AB DICK 360,375 & 9800

(1) A-36354	360 Universal Head Clamp Assy	\$712.00
(1) A-37354	375 Universal Head Clamp Assy	\$781.00
(2) A-36359	Anchor Bracket	\$128.95
(3) A-37353	Stop Plate	\$245.00
(4) A-36299	Hinge 360,375	\$ 11.80
(4) A-892	Socket Head Screws	\$ 0.75
(6) A-K-36349	Spring Kit	\$

Lateral Adjusting, & Vertical Adjusting Knob

Lateral Adjusting Kit

Vertical Adjusting Kit

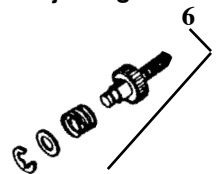
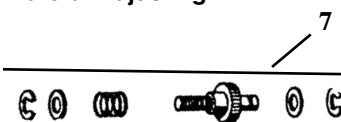

Lateral Adjusting Kit	A-36351	\$
Vertical Adjusting Kit	A-36311	\$

G-120 Chain Lubricant & Protector \$

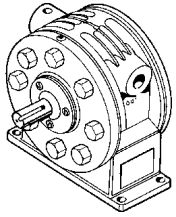

Multilith or AB Dick

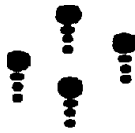

Rubber WASHER

NEW & Rebuilt VACUUM PUMP

120-2010	Vacuum Pump (NEW)	\$1,679.90
A-1000000	Rebuilt Vacuum Pump	\$ 459.00
P-1182		
72840	(4) Rubber Washer	\$ 1.65 ea

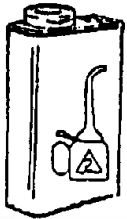

Use the right Oil

Recommended for vacuum pumps, compressors, small bearings and other moving parts. Prevents gum or sludge and foam.

D-747... Oil \$



GAST FLUSHING OIL

- Combination of additives makes true anti wear lubricant.
 - Powerful sludge dispersant loosens dirt & cleans pump.
 - Antirust ingredient protects internal parts.
 - Lubricates and cleans vacuum pumps.
- (14 OZ. Can) NO AH 255B... \$

WORK Is A Great Factor.

He who has learn to work and love work Is indeed fortunate for no Investment pays greater dividends. But there is the clock watcher with one eye on the door and the other on the go. A man can make himself what he will and whether his rewards are great or small he has only himself to think about.

He who has learn to love work is indeed fortunate.

For AB Dick 350, 360, 375, 9800, 385, & Multilith Chief Compressor

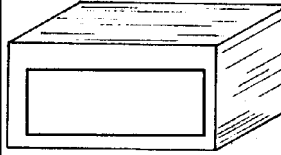

New Parts include : Vanes, Ball Bearing, Felt Shaft, Seal, Body Spacer, End Cap Gasket, Oiler Cover, Oiler wick and Cover Gasket

.....F-753 Kit

\$

REBUILT VACUUM PUMP

SOLD ON

Exchange only Core Deposit Required

E-mail presslineonline@gmail.com

AB- 421 Rebuilt Vacuum Pump \$

Plugged Air hole will cause oil to blow back through air lines.

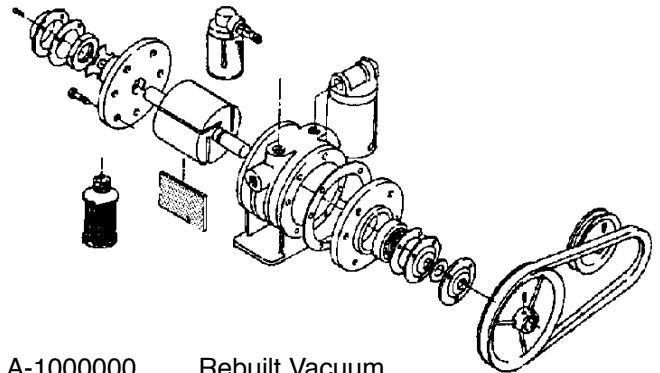

A-1000000 Rebuilt Vacuum Pump Kit \$174.20
P-1182

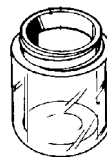

72261	Gasket	\$4.50
72852	Plastic	\$8.60
72855	Filter	\$1.60

Check for Bottle Cracks

Pressline Printing Equipment Inc.
This website has only sample of our total inventory of over 5000 different items & parts in stock if you don't see it just E-mail presslineonline@gmail.com Just Call 360-674-2009

AB Dick Rubber Sucker

3980 / 9985 / 2800 / 3200 / 3302M
500N / 500K/



From Standard Rubber Sucker

5290-33-314	(1 Dozen)	\$
Pressline After Market Standard Rubber Sucker		
R-5208	(1 Dozen)	\$24.00
Pressline Black Heavy Rubber Sucker		
R-33314-B	(1 Dozen Heavy)	\$12.50

AB 3985/ 9985/ 3302M Feed Retainer

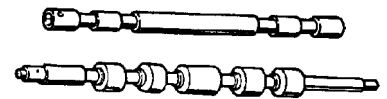
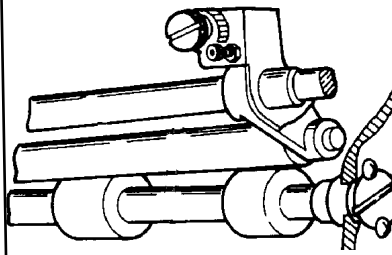

Lower Feed Roller

1.	5341-36-531	Upper Feed Roller	\$
2.	5340-36-220	Lower Feed Roller	\$
3.	RY-90352	Bearing Feed Roller.....	\$

3302M Feeder Pullout Roller Check for Wear Pullout Rollers



5330-35-330Z-1 \$54.00

For Use on all Models 3200M, Itek
3980,3985,

Precision made from high quality materials and workmanship to produce accurate paper feeding and long life. Synthetic rubber molded to a steel core. With precision needle bearing for smooth and dependable operation.

AB 3985/9985/ Hand Crank

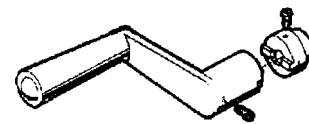

1.	5310-37-810	Paper Table Crank Assy	\$226.55
1.	5310-88-160	Chain Table Crank Assy	\$150.00

Feed Drum Gripper & Stopper

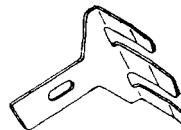

1	5341-36-550	Urethane Coated	\$19.90
1A.	5341-36-550	Diamond Coated	\$
2.	5340-36-555	Stopper Finger	\$8.40
3	9648 03 0614	Socket Bolt 3x10M (Set of 7)	\$3.40

CONVEYOR JOGGER GUIDE SPRING Ryobi Jogger Springs

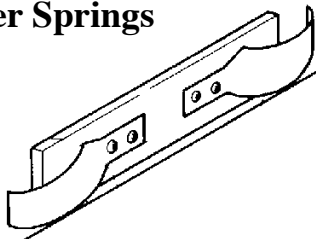

5341-35-882 Jogger Spring Thick Paper \$4.40
5341-35-883 Jogger Spring Thin Paper \$7.95

AB 9980, 3302M Gripper Bar & Chain

Ryobi Gripper Adjustment Gauge Takes the Guess
work out of Setting the Gripper Order# R-4455 \$

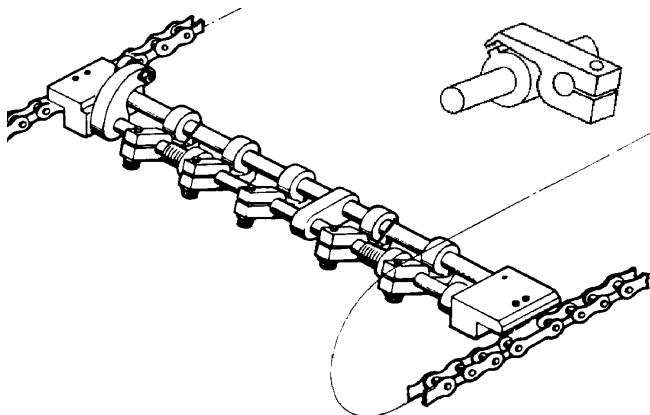

AB 9980, 3302M Gripper Bar & Chain

1.	5310-87-3012	Gripper Assembly Old Style	\$360.00
1A.	5310-87-3012	Gripper Assembly Urethane	\$360.00
1B.	5310-87-3012	Gripper Assembly Diamond	\$
2.	5300-87-412	NS 1 to 1 Chain (Assembly 2)	\$149.00
2.	5300-87-410	OS Chain (Assembly 2)	\$149.00
3.	5340-87-321	Gripper Spring	\$ 3.50
4.	R-90-203	Bearing	\$ 7.00
5.	5290-87-322	Center Bracket	\$34.25
6.	5290-87-3182	Gripper Finger Old Style	\$34.25
6A.	5321-87-3182	Gripper Finger Urethane	\$23.45
6B.	R-873182	Gripper Finger Diamond	\$

Tip Sheet: Sold With Gripper Bar or Chain With Proper Installation & adjustment.

Plate Cylinder Parts 3980, 9985

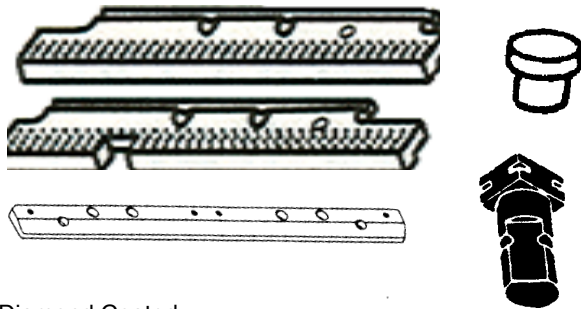

Diamond Coated

RYOBI 3302M Plate Head Clamps
Diamond Coated For Sure Grip and Longer and Longer use.

1	5344-54-662	Head Clamp	\$229.90
1	5344-54-642	Tail Clamp	\$229.90
3.	R-54-629L	SN/6186 & Lower Pin	\$
3A	R-54-629H	SN/6187 & Higher	\$
4A.	5344-54-633-2	Lock Pin	\$ 14.45
3	5640-75-244	Clamp Spring (Set of 8)	\$ 2.95

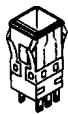

3302M For Control Panel (Switch Body)
R-98564 \$

3980, 9985 Impression Cylinder

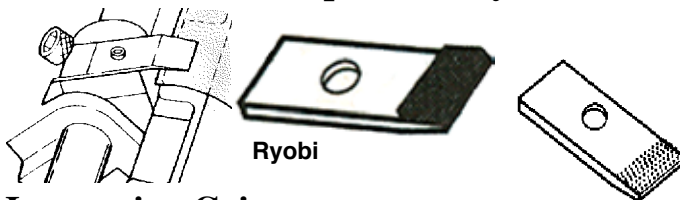

Impression Gripper

1	5340-23-240	Urethane Coated	\$23.50
1A.	6340-23-240-D	Diamond Coated	\$
2.	9648 030 614	Screw Set 3X6M	\$ 0.45

Tech Sheet Sold With Installation Instructions Sheet.
Bad Impression Cylinder Register Can Be one Urethane Gripper.
Or maybe the Adjustment was not done to Ryobi Instruction.

Paper Feed Board Retainer Spring



5340-35-552	For Thin Paper	\$19.50
5340-35-556	For Thick Paper	\$15.90
5340-35-557	For Thick Paper	\$27.00

AB Dick 3980, 9985 Clean Up Unit

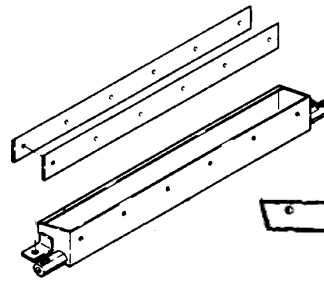

**INK CLEAN UP
BLADES**
Ryobi 3302M, Itek 3980,
3985
ITEK & RYOBI

1.	5340-52-524-1	Clean up Blade	\$29.00
2.	9642 041 1014	Clean up Blade Screw (M4X10)	\$.45

Impression Cylinder Main Spring 3980, 9985

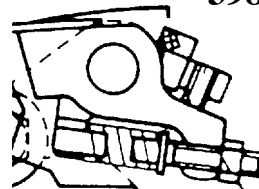

1	5340-23-233	Impression Spring	\$9.15
---	-------------	-------------------	--------

Tip Old springs loose some of their resistance over time and the 3302M is susceptible to Bad Register should be replaced if Press Is over 5 yrs, old Its not a big cost. Sold With Installation Instructions Sheet.

3980, 9985 Drive Shaft Assy

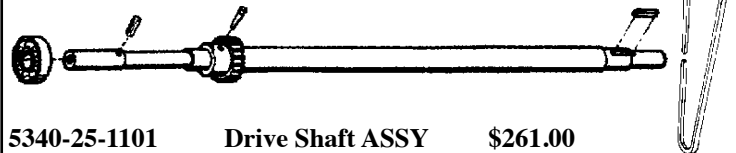

5340-25-1101	Drive Shaft ASSY	\$261.00
90207	Bearing 6203LLB	\$9.50
R-90072	Drive V-belt 3V 670	\$21.30

Tip Replacement of 3302M Drive Shaft Not Done Right Can Damage Your Impression Cylinder.

Itek/3980, 9985 Clamp/Paper Guide Old Style & New Style



Slide Thickness

1	5290-32-211	5.5mm Clamp (OS)	\$26.15
1A	5290-32-212	5mm Slide Plate (OS)	\$106.90
2	R-32-211-2	7mm Clamp (NS)	\$
2A	R-32-212-2	6.5mm Slide Plate (NS)	\$
3	5290-32-141	Clamp Knob	\$11.70

USED CLAMP REPAIR

See Ryobi Used Parts List for prices.

AB Dick 3980, 9985 VACUUM PARTS

Sold with installation and instructions sheet

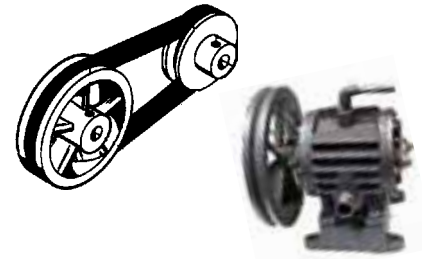
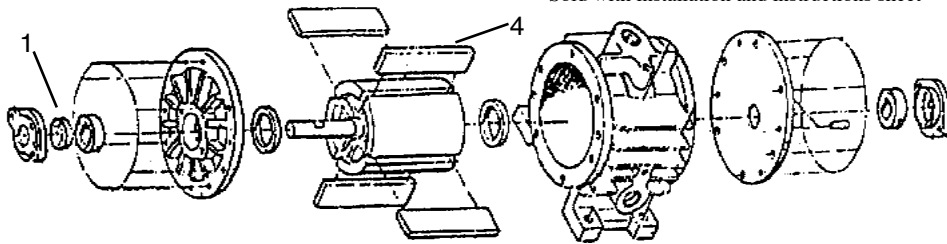

Vacuum Pump V-belt
 R-90101 V-belt A-35 \$
 R-90102 V-belt A-36 \$

5290-16-2003 New Pump

1.	90541 Seal	\$	
2.	90296 Ball Bearing	\$	10.20
3.	5290-16-237 Ring	\$	
4.	5290-16-227 Blades	\$	76.10
5.	5290-91-150 Wick	\$	1.90

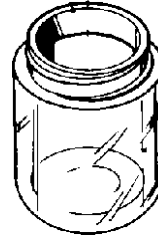

5290-16-312 Gasket..... \$ 9.90
 5290-16-311 Plastic Bottle \$25.70
 5290-16-313 Filter \$ 1.90

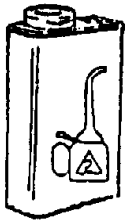

Use the right Oil



Recommended for vacuum pumps, compressors, small bearings and other moving parts

D-747 Oil

FLUSHING OIL

- Combination of additives makes true anti wear lubricant.
- Powerful sludge dispersant loosens dirt, & cleans pump.

- Antirust ingredient protects internal parts.
 - Lubricates and cleans vacuum pumps.
- AB- 422 ONE QUART (.945 Liters) \$

Check Your Air Filter

AB Dick 3980, 9985 AIR BLOWER

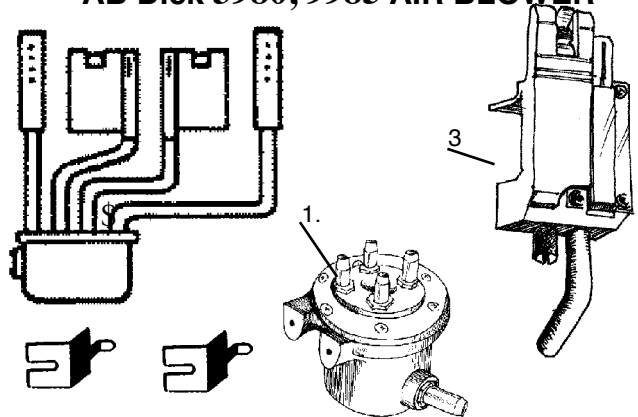

AIR TERMINAL RYOBI 2800,3200,3302M,500

1.	5290-17-120 Air Terminal Plastic	\$ 36.00
1	5290-17-120-1 Air Terminal Cast Iron	\$ 45.00

Air Sheet Separator Bracket

3.	5290-32-420 Air Bracket OP Left	\$122.00
3	5290-32-430 Air Bracket NP Right	\$122.00

Sheet Separator

From Ryobi Sheet Separators
 2800/3200/3302M/500N/500K

5290-32-451 (12 Dozen) \$

Pressline Ryobi Sheet Separators After Market
 2800 / 3200 / 3302M / 500N / 500K/

R-27114 Thick Brass for Envelopes & Card Stock
 (1 Dozen) \$ 15.00

R-71409-B Thin Copper (1 Dozen) \$ 25.00

Ryobi 3302M & AB 98885

(4) Feed Board Tape

5340-35-534-1 \$

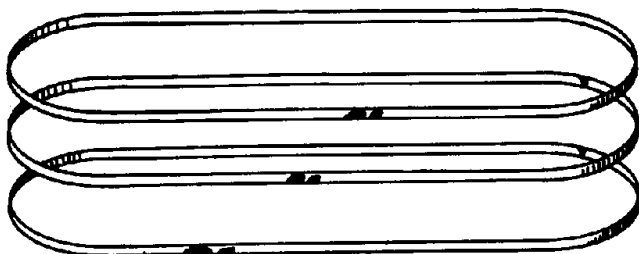

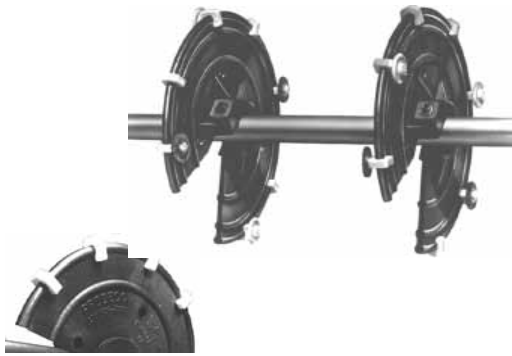

- Prevents Marking and Tracking of Stock at the Delivery end.
- Fully Adjustable Tef-clean Feet Let You Position for Perfection Based on Where Copy Falls on the Sheet.
- Replace, for good, those Outdated Wheels and Get Clean Copy.

AB DICK

AB - 433 \$



Produce-No-Mark - Potential Accessories Kit. Tef- clean Wheel Set. (Free Spinning). For Running Heavier Weight of Coated Stock.

D-779 -Tef-clean Wheels (Set of 12) \$

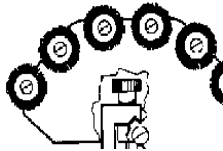

Brush Wheel (Free Spinning). For running light weight paper or running printing with High Halftone Coverage Jobs.

D-779-BW Brush Wheel (Set of 12) \$

Itek 3980, 3985 RYOBI 3302M

- Stop Tracking
- They spin with the stock for gentle Floating Kiss impression.

Replaces those old style metal spiked guide wheels that scratch and mark stocks.

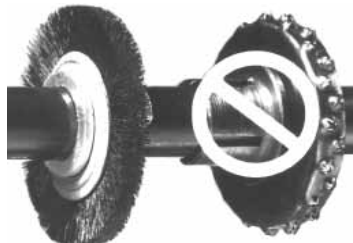

AB - 444 Star Brushes (Set of 24) \$

For Presses with a 1.5 to 1" delivery

Old Style Chain compatible. Fully adjustable to any point on the wheel for more demanding print work. No-mark Accessories

AB DICK 350, 360, 375
Old Style Chain.



AB - 445 No-Mark Star wheel \$

Now available for Your Mid Sized Job Press

AB DICK 375, 9800, Itek 3985, Ryobi 3302M

- Developed by a Pressman

Mark-Less Super Blue is a cast aluminum cylinder with a frictionless surface covered by a loose fitting Ink and Water repellent (The Cylinder) mounts right on your Skeleton Wheel shaft, Super Blue, delivering a truly Mark-Less Sheet, Super Blue Systems.

- Deliver a True Mark-Less Sheet.
- Very Easy To Install.
- Allows You To Run Solids And Screens On Coated Stock And

GUARANTEED PERFORMANCE

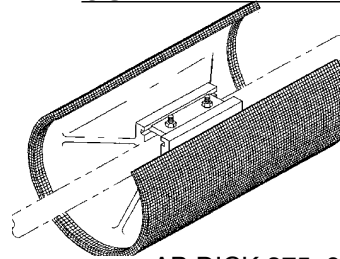

AB DICK 375, 9800 \$
Itek 3985, Ryobi 3302M \$
....Replacement Net 2-36x36 Net
Trim As needed -Blue Net \$

UNIVERSAL BRUSH SKID WHEEL ASSEMBLY

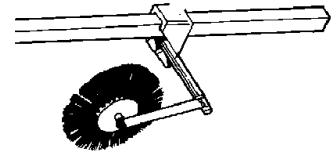
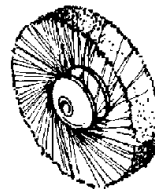

Control Register, Easy to Adjust. Work with Side Jogger Stop. Back Lash just like the Big Presses. Mount on Ryobi 3302M Roller Bracket.

R-8200 Brush Assembly \$

T-51 PARTS

1. Old Style 350-360
22049 Bottle W/Cap..... \$
D-200

1, New Style 360 9800
D-500 Bottle W/Cap..... \$
T-500
New Style.....
2. 51749 Bottle..... \$

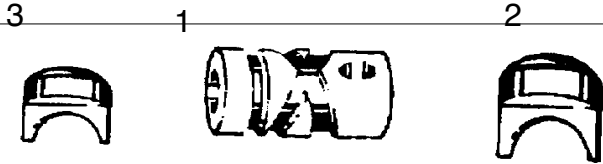
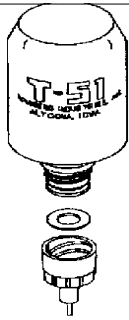

1. T-1802 Worm Old Style \$ 85.02
3. T-1804 Dog (OS) \$ 69.00
. T-1804-S SET (Worm, Dog & Screw) **\$140.00**

1. T-1802 Worm New Style \$ 85.00
2. T-4804 Dog (NS) \$ 57.80
5. T-4804-S SET (Worm, Dog & Screw) **\$140.00**



SPRING RETAINER

Weak Spring Will Cause Dog & Worm to Go Out.
Also spin cleaning will cause dog & worm to go out.
4645 Dog Retainer **\$147.00**

Transfer Roller Bushing & Bearing.



T-7826 Transfer Bushing \$37.00
T-900002 Transfer Bearing \$5.90

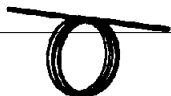
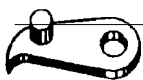

T-1570 Ink (Right) \$15.90
T-1572 Ink Spring Red..... \$7.40
T-1571 Water (Left)..... \$15.90
T-1573 Water Spring Left..... \$7.40

Check Our Website

AB Dick press parts list for sale prices & parts in stock New & Used.

T-51 PARTS

Plate Micro Adjustment.



1 T-7153 Micro Screw \$21.00
2 T-7151 Clamp \$29.95
3 T-4175 Post \$32.00



(NS)
Drive Collar & Gear

T-8407 Drive Gear Assy \$98.00



DRIVE PULLEY (9800 series)

T-22444\$85.50



GEAR BELT (9800 series)

T-960421\$13.80

T-51 T-Wrench

T-1132 T-Wrench \$29.85



**Stop Water From Dripping
on Your Printing!**

T-8768 Drip Tray (OS) 350 & 360 \$ 64.10
T-8769 Square Frame (360) \$
T38768 Square Frame (375) \$
T-9768 Drip Tray (NS) (9800) \$ 64.10

OLD Style

Square Frame

New Style

